

DAMAC

PREMIUM DATACENTER PRODUCTS

IT / Data Center Solutions

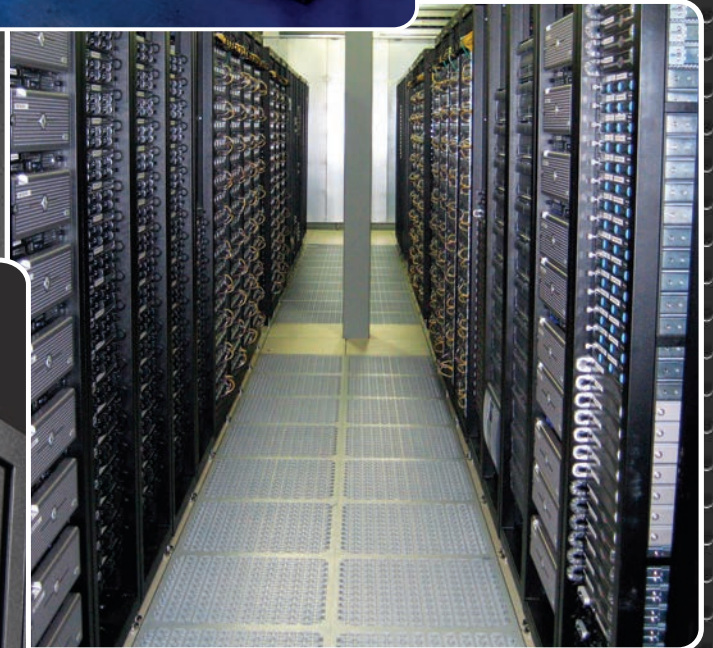
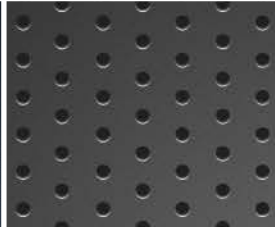

MADE IN U.S.A.

Ladder Style Cable Runway

COMPATIBLE
w/ other popular
MANUFACTURERS

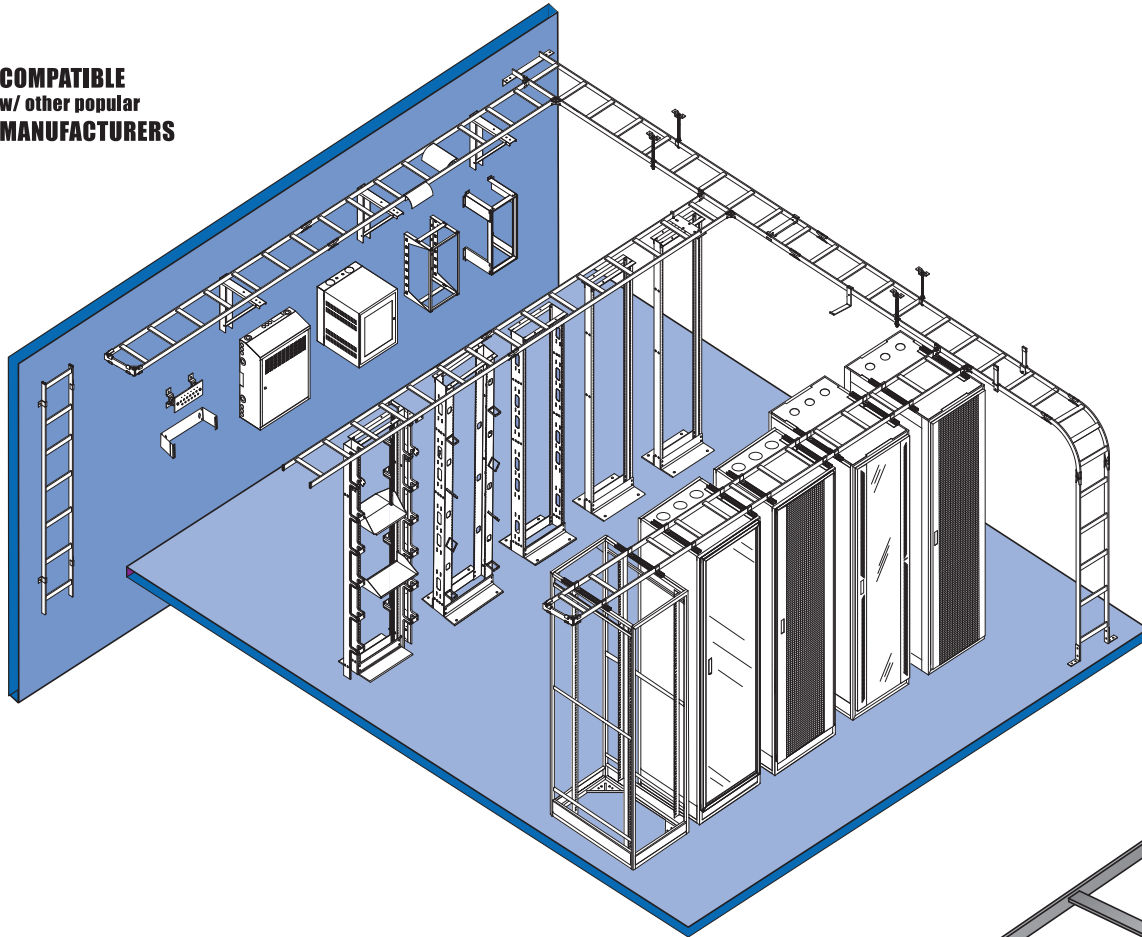

Cable Runway

Cable runway is constructed of tubular steel, providing superior strength and less weight. Each stick of cable runway is individually boxed for easy shipment. Available in standard or Telco versions. Completely compatible with other cable runway systems. Save up to 20% of the cost compared to similar runway systems. Available in black or gray epoxy powder-coat finish.

Specifications:

- Construction: 16 GA, 3/8" x 1-1/2" x .065" tubular steel
- Standard length: 9' 11-1/2"
- Standard: cross members positioned on 12" centers
- Telco: cross members positioned on 9" centers
- Compatible with other tubular cable runway systems
- Full line of hardware and accessories available
- Individually boxed for easy shipment
- Epoxy powder-coat finish: black or gray

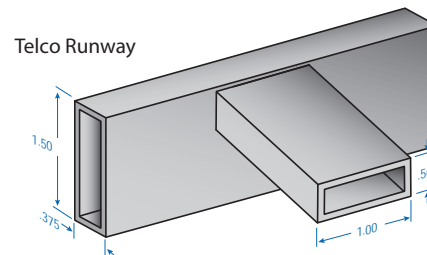
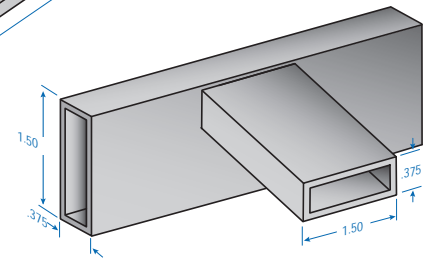
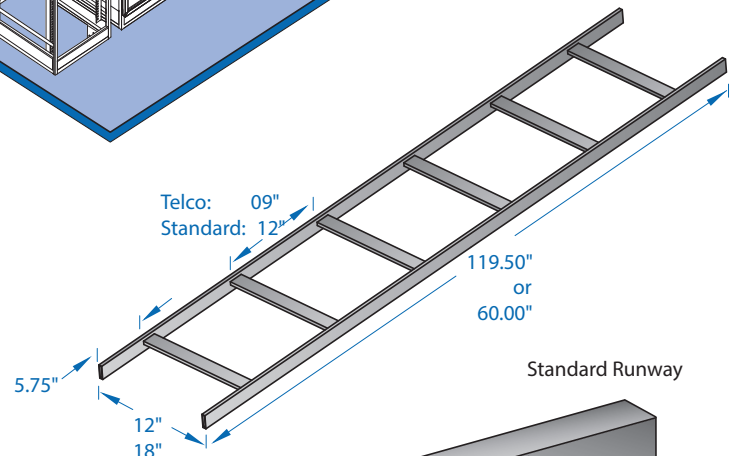

Cable Runway

| Part # | H x W x L | Type | Color | Wt. |
|------------|----------------------|------------------|-------|--------|
| PLR1205-3 | 1.5" x 12" x 60.00" | 12" Runway | Black | 10 lb. |
| PLR1210-3 | 1.5" x 12" x 119.50" | 12" Runway | Black | 20 lb. |
| PLR1805-3 | 1.5" x 18" x 60.00" | 18" Runway | Black | 15 lb. |
| PLR1810-3 | 1.5" x 18" x 119.50" | 18" Runway | Black | 30 lb. |
| PLR1210T-3 | 1.5" x 12" x 116.50" | 12" Telco Runway | Black | 20 lb. |

* replace (-3) in part# with (-4F) for Gray Color, (-5F) White Color

90 Degree Radius E-Bends

Provides a gradual bend for cable runway, maintains min. cable bend radius

| Part # | Description | Color | Wt. |
|-----------|---|-------|--------|
| PLR12RE-3 | 12" Runway, 90 Degree Horizontal Radius | Black | 8 lb. |
| PLR18RE-3 | 18" Runway, 90 Degree Horizontal Radius | Black | 11 lb. |

* replace (-3) in part# with (-4F) for Gray Color, (-5F) White Color

Radius Bends: Inside

Inside bend for cascading cables, maintains min. cable bend radius

| Part # | Description | Color | Wt. |
|-----------|--------------------------------|-------|--------|
| PLR12RI-3 | 12" Runway, Inside Radius Bend | Black | 8 lb. |
| PLR18RI-3 | 18" Runway, Inside Radius Bend | Black | 11 lb. |

* replace (-3) in part# with (-4F) for Gray Color, (-5F) White Color

Radius Bends: Outside

Outside bend for cascading cables, maintains min. cable bend radius

| Part # | Description | Color | Wt. |
|-----------|--------------------------------|-------|--------|
| PLR12RO-3 | 12" Runway, Inside Radius Bend | Black | 8 lb. |
| PLR18RO-3 | 18" Runway, Inside Radius Bend | Black | 11 lb. |

* replace (-3) in part# with (-4F) for Gray Color, (-5F) White Color

Radius Drop

Maintains cable bend radius for center cascading cables. Attaches to cable runway stringer our cross-bar. Fits 12" and 18" cable runway.

| Part # | Description | Color | Wt. |
|-----------|-------------------------|-------|-------|
| PLBDS-3 | Runway Side Drop | Black | 2 lb. |
| PLBDST-3 | Telco Runway Side Drop | Black | 2 lb. |
| PLA12DC-3 | 12" Runway, Center Drop | Black | 2 lb. |
| PLA18DC-3 | 18" Runway, Center Drop | Black | 3 lb. |

* replace (-3) in part# with (-4F) for Gray Color, (-5F) White Color

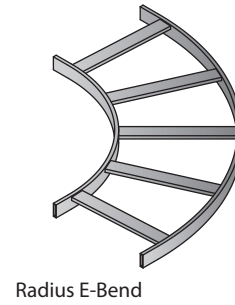
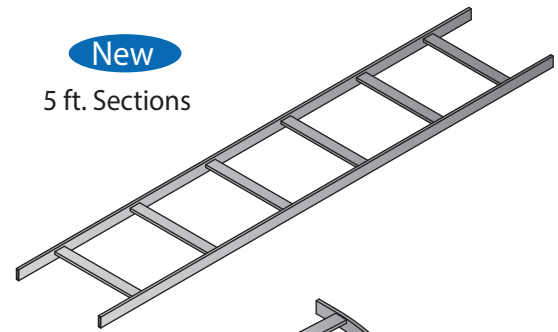

Radius E-Bend

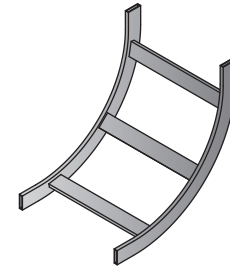

Inside Radius Bend

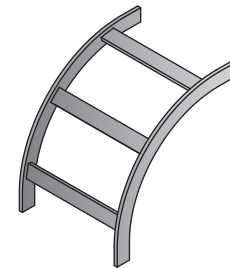

Outside Radius Bend

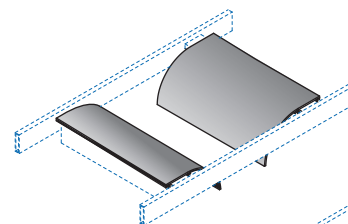

Center Drop

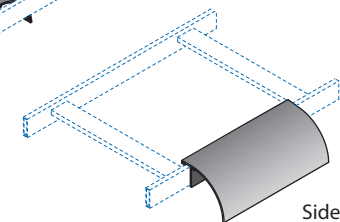

Side Drop

Ladder Style Cable Runway

Adjustable Cross Member

Facilitates the cascading of cables between runway cross-members. Kit includes cross-member w/ hardware.

| Part # | Description | Color | Wt. |
|------------|-----------------------------|-------|-------|
| PLA12CM-3 | 12" Adjustable Cross Member | Black | 2 lb. |
| PLA12CM-4F | 12" Adjustable Cross Member | Gray | 2 lb. |
| PLA18CM-3 | 18" Adjustable Cross Member | Black | 2 lb. |
| PLA18CM-4F | 18" Adjustable Cross Member | Gray | 2 lb. |

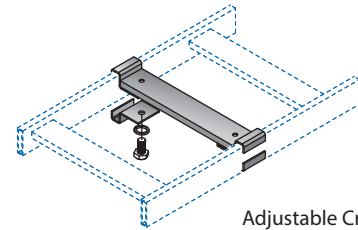

Adjustable Cross Member

Stand-Off Support Bracket

Add an additional cable runway system directly above, perpendicular or parallel, to an existing runway system. Kit includes four support brackets, two steel 12" angled stand-off beams and all required hardware.

| Part # | Description | Color | Wt. |
|------------|-------------------------------|-------|-------|
| PLB12SK-3 | 12" Stand-Off Support Bracket | Black | 2 lb. |
| PLB12SK-4F | 12" Stand-Off Support Bracket | Gray | 2 lb. |

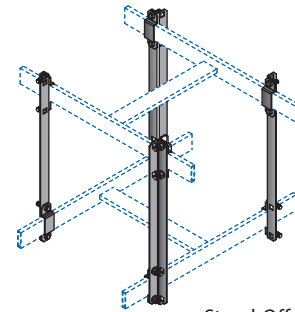

Stand-Off Bracket

Retaining Post

Adds additional depth to cable runway for dense cabling. Kit includes one 6", 8" or 10" retaining post, mounting bracket, protective end caps and all required hardware.

| Part # | Description | Color | Wt. |
|------------|--------------------|-------|-------|
| PLB06RP-3 | 06" Retaining Post | Black | 2 lb. |
| PLB06RP-4F | 06" Retaining Post | Gray | 2 lb. |
| PLB08RP-3 | 08" Retaining Post | Black | 2 lb. |
| PLB08RP-4F | 08" Retaining Post | Gray | 2 lb. |
| PLB10RP-3 | 10" Retaining Post | Black | 3 lb. |
| PLB10RP-4F | 10" Retaining Post | Gray | 3 lb. |

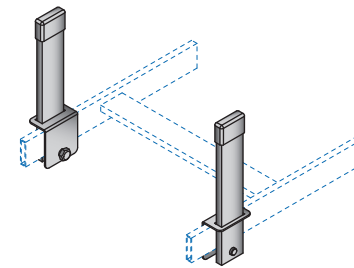

Retaining Post

Termination Kits

Termination kits close an un-spliced end of cable runway. Kits feature two junction "T" brackets, one piece of 1 1/2" tube at a length equal to the un-spliced cable runway and all needed hardware.

| Part # | Description | Color | Wt. |
|------------|-------------------------|-------|-------|
| PLBTK12-3 | 12" Runway, Termination | Black | 3 lb. |
| PLBTK12-4F | 12" Runway, Termination | Gray | 3 lb. |
| PLBTK18-3 | 18" Runway, Termination | Black | 5 lb. |
| PLBTK18-4F | 18" Runway, Termination | Gray | 5 lb. |

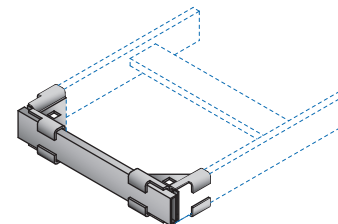

Termination Kit

L Bracket

Ideal for physically separating required cables. By adding the "L" bracket, an alternative runway is created for separating harmful power cables from data cables. Kit includes "L" bracket and hardware.

| Part # | Description | Color | Wt. |
|-----------|--------------------------|-------|-------|
| PLA5LB-3 | "L" Bracket Cable Runway | Black | 1 lb. |
| PLA5LB-4F | "L" Bracket Cable Runway | Gray | 1 lb. |

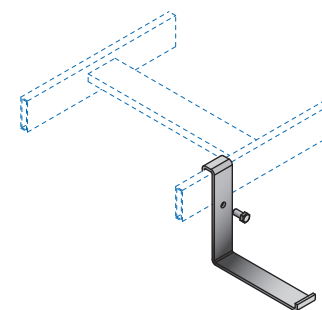

"L" Bracket

Rack-To-Runway Elevation Kit

Support runway above racks with added top spacing for cable transitions. Mounts to rack-to-runway mounting plate (PLBXXRS-3) and to side stringer of runway with elevation adjustments from 2"-3" and 4"-6" high. Kit includes two elevation brackets w/ hardware. Top plate sold separately.

| Part # | Description | Color | Wt. |
|-----------|---|-------|-------|
| PLBSC06-3 | Rack-Runway Elevation Kit, 4" - 6" High | Black | 8 lb. |
| PLBSC03-3 | Rack-Runway Elevation Kit, 2" - 3" High | Black | 8 lb. |

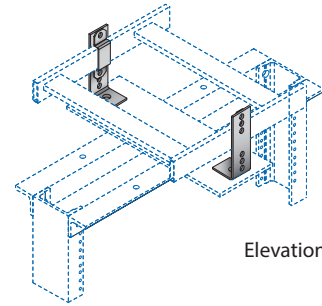

Elevation Kit

Runway-To-Rack Mounting Kit

Securely attaches cable runway to the top angles of standard 3" channel relay racks. Allows mounting runway either parallel or perpendicular to the rack. Kit includes one steel, pre-drilled mounting plate and two 5/16-18 x 3" J-bolts w/ hardware.

| Part # | Description | Color | Wt. |
|------------|------------------------------|-------|-------|
| PLB12RS-3 | 12"W Runway to Two Post Rack | Black | 2 lb. |
| PLB12RS-4F | 12"W Runway to Two Post Rack | Gray | 2 lb. |
| PLB18RS-3 | 18"W Runway to Two Post Rack | Black | 3 lb. |
| PLB18RS-4F | 18"W Runway to Two Post Rack | Gray | 3 lb. |

FIG. 1

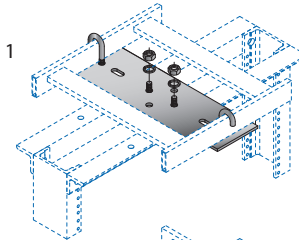
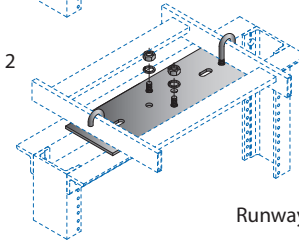

FIG. 2



Runway/Rack Mounting Kit

Runway-To-Cabinet Mounting Kit

Securely attaches runway to the top of cabinets. Kit includes mounting plate that allows you to adjust runway into the desired position.

| Part # | Description | Color | Wt. |
|------------|---|-------|-------|
| PLB24CS-3 | 12"-18"W Runway to 24"-30"D Cabinet Kit | Black | 7 lb. |
| PLB24CS-4F | 12"-18"W Runway to 24"-30"D Cabinet Kit | Gray | 7 lb. |
| PLB28CS-3 | 12"-18"W Runway to 28"-40"D Cabinet Kit | Black | 7 lb. |
| PLB28CS-4F | 12"-18"W Runway to 28"-40"D Cabinet Kit | Gray | 7 lb. |

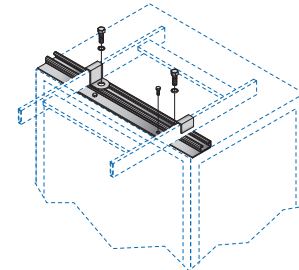

Runway/Cabinet Mounting Kit

Wall Angle Support Kit

Wall angles function as a wall support and seismic bracing for cable runway. Kit includes a pre-drilled, steel wall angle plate and a two 5/16-18 x 3" J-bolts and all needed hardware.

| Part # | Description | Color | Wt. |
|------------|-------------------------------|-------|-------|
| PLBWA12-3 | 12" Runway Wall Angle Bracket | Black | 4 lb. |
| PLBWA12-4F | 12" Runway Wall Angle Bracket | Gray | 4 lb. |
| PLBWA18-3 | 18" Runway Wall Angle Bracket | Black | 5 lb. |
| PLBWA18-4F | 18" Runway Wall Angle Bracket | Gray | 5 lb. |

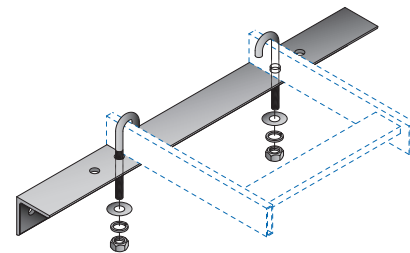

Wall Angle Support Kit

Wall Mounting Clamps

Wall clamps are a quick and easy solution for attaching cable runway to wall surfaces. Kit includes two mounting clamps and all needed hardware.

| Part # | Description | Color | Wt. |
|------------|--------------------------------------|-------|-------|
| PLBWHC2-3 | Wall Mounting Hold Down Brackets (2) | Black | 1 lb. |
| PLBWHC2-4F | Wall Mounting Hold Down Brackets (2) | Gray | 1 lb. |

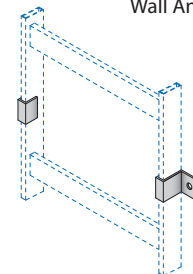

Wall Mounting Clamps

Ladder Style Cable Runway

Wall Triangle Support Kit

The steel triangle wall support bracket provides wall support for cable runway. Kit features a pre-drilled, triangle bracket, two 5/16-18 x 3" J-bolts and hardware.

| Part # | Description | Color | Wt. |
|------------|----------------------------------|-------|-------|
| PLBWT12-3 | 12" Runway Triangle Sup. Bracket | Black | 5 lb. |
| PLBWT12-4F | 12" Runway Triangle Sup. Bracket | Gray | 5 lb. |
| PLBWT18-3 | 18" Runway Triangle Sup. Bracket | Black | 8 lb. |
| PLBWT18-4F | 18" Runway Triangle Sup. Bracket | Gray | 8 lb. |

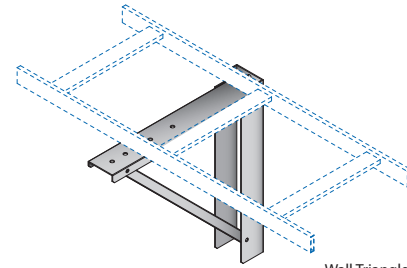

Wall Triangle Support Kit

Ceiling Support Kits

Suspend runway from the ceiling. Kit includes one rack support bracket, one ceiling support bracket and one 6' piece of 5/8" threaded rod w/ all needed 5/8" hardware. Note: two kits are req. for standard configuration.

| Part # | Description | Color | Wt. |
|------------|--|-------|-------|
| PLBCRK58-3 | 5/8" Ceiling Support Kit w/ rod | Black | 5 lb. |
| PLBC58-3 | 5/8" Ceiling Bracket, 1 only | Black | 1 lb. |
| PLBSS58-3 | 5/8" Slotted Support Bracket, 1 only | Black | 1 lb. |
| PLA58072TR | 5/8" Threaded Rod, 6 ft. Piece, 1 only | Zinc | 5 lb. |

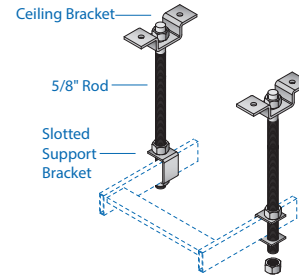

Runway Ceiling Support Kit

Floor Mounting Kits

The floor mounting kit includes two butt splice brackets, floor angles and all needed hardware.

| Part # | Description | Color | Wt. |
|---------|------------------------|-------|-------|
| PLBFS-3 | Floor Mounting Kit (2) | Black | 6 lb. |

* replace (-3) in part# with (-4F) for Gray finish

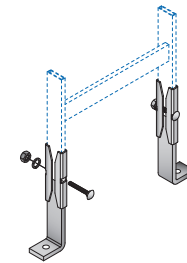

Runway Floor Mounting Kit's

Butt Splice Kit

Use to splice cable runway. Kit includes two brackets w/ hardware. The HD model requires drilling.

| Part # | Description | Color | Wt. |
|------------|---------------------------------|-------|-------|
| PLBE00-3 | Bracket, Butt Splice Kit (2) | Black | 2 lb. |
| PLBE00HD-3 | Bracket, HD Butt Splice Kit (2) | Black | 2 lb. |

* replace (-3) in part# with (-4F) for Gray finish

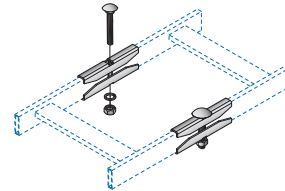

Butt Splice

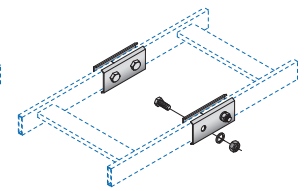

HD Butt Splice

Junction-T Kit

Create a 90 degree junction splice. Kit includes two brackets w/ hardware. HD model requires drilling.

| Part # | Description | Color | Wt. |
|-----------|--------------------------------|-------|-------|
| PLBJT-3 | Bracket, Junction T Kit (2) | Black | 2 lb. |
| PLBJTHD-3 | HD Bracket, Junction T Kit (2) | Black | 3 lb. |

* replace (-3) in part# with (-4F) for Gray finish

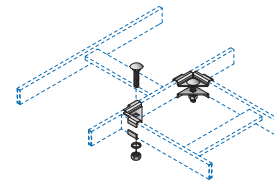

Junction T

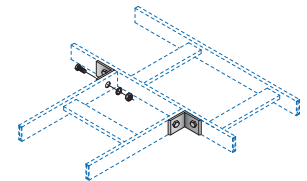

HD Junction T

30-90 Adjustable Junction Kit

Form virtually any adjustable angle for splicing to cable runway. Bracket attaches to side stringer of runway and easily slides between cross-bars. Kit includes two adjustable junction brackets w/ hardware.

| Part # | Description | Color | Wt. |
|------------|--------------------------------------|-------|-------|
| PLBJ3090-3 | Bracket, 30-90 Adj. Junction Kit (2) | Black | 5 lb. |

* replace (-3) in part# with (-4F) for Gray finish

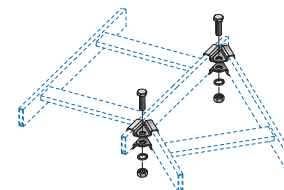

30-90 Junction Kit

Cable Runway

45 Degree Splice Kit

Use to splice cable runway at a 45 degree angle. Kit includes two 45 degree splice brackets w/ hardware.

| Part # | Description | Color | Wt. |
|----------|-----------------------------------|-------|-------|
| PLBE45-3 | Bracket, 45 Degree Splice Kit (2) | Black | 2 lb. |

* replace (-3) in part# with (-4F) for Gray finish

90 Degree Splice Kit

Use to splice cable runway at a 90 degree angle. Kit includes two 90 degree splice brackets w/ hardware.

| Part # | Description | Color | Wt. |
|----------|-----------------------------------|-------|-------|
| PLBE90-3 | Bracket, 90 Degree Splice Kit (2) | Black | 2 lb. |

* replace (-3) in part# with (-4F) for Gray finish

Swivel Splice Kit

Butt splices cable runway horizontally, vertically or perpendicularly. Adjusts to virtually any angle making it easy to install runway around existing obstacles. Kit includes two swivel splice brackets w/ hardware.

| Part # | Description | Color | Wt. |
|---------|---|-------|-------|
| PLBSE-3 | Bracket, Butt-Swivel Splice Kit (2) | Black | 2 lb. |
| PLBSJ-3 | Bracket, Junction-Swivel Splice Kit (2) | Black | 2 lb. |
| PLBSV-3 | Bracket, Vertical-Swivel Splice Kit (2) | Black | 2 lb. |

* replace (-3) in part# with (-4F) for Gray finish

Grounding Strap

Creates a common ground between spliced ladder rack sections. Kit includes one braided copper ground strap and all needed hardware. Installation requires drilling of two holes for mounting.

| Part # | Description | Color | Wt. |
|---------|---------------------------------|-------|-------|
| PLA12GK | 12" Grounding Strap w/ Hardware | Zinc | 1 lb. |

Wall Mounted Copper Bus Bar

Wall mounted bus bar includes a 10" x 4" or 20" x 4" copper grounding bar and all needed mounting hardware

| Part # | Description | Color | Wt. |
|---------|---------------------------------|--------|-------|
| AGWB010 | 10" x 4" Wall Mount Bus Bar Kit | Copper | 5 lb. |
| AGWB020 | 20" x 4" Wall Mount Bus Bar Kit | Copper | 9 lb. |

Protective End Caps

Rubberized end caps for exposed ends of cable runway. Helps protect workers and equipment from exposed areas. Sold in pairs.

| Part # | Description | Color | Wt. |
|--------|--------------------------------|-------|-------|
| PLAEC | Runway Rubberized End Caps (2) | Black | 1 lb. |

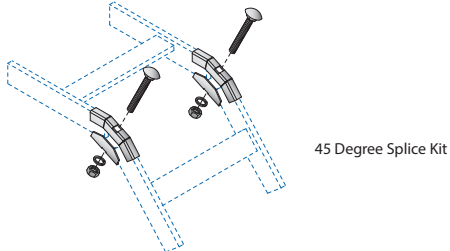

45 Degree Splice Kit

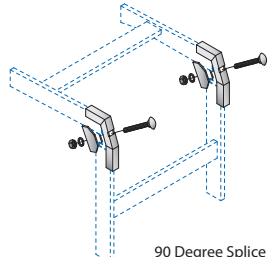

90 Degree Splice Kit

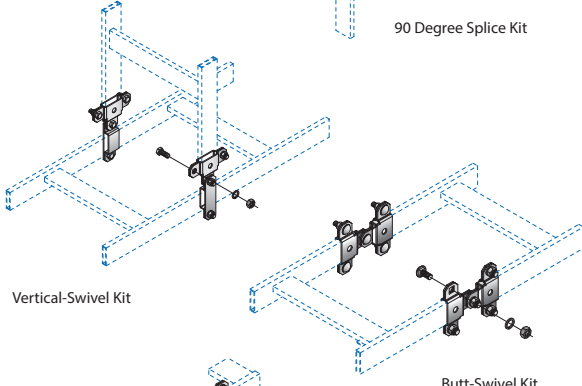

Vertical-Swivel Kit

Butt-Swivel Kit

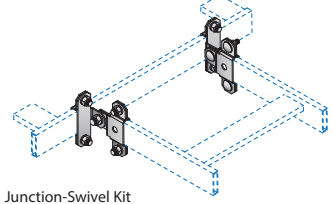

Junction-Swivel Kit

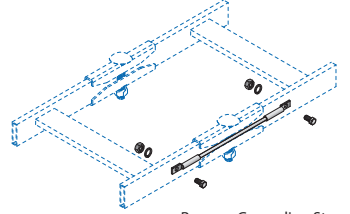

Runway Grounding Strap

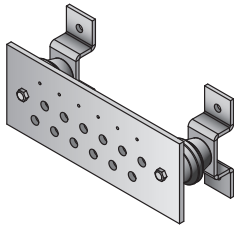

Wall Mounted Copper Bus Bar

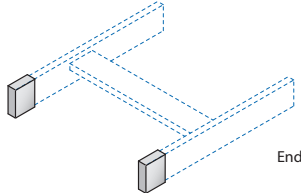

End Caps

Ladder Style Cable Runway

J-Bolt Kits

Used to attach ladder rack to framing, channels, etc. J bolts come in 5/16-18 and are available in lengths of 2.25" or 3.00". Finished in gold zinc, kits include two J-bolts, washers and hex nuts.

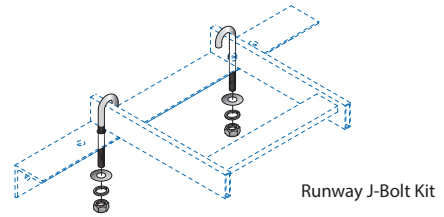

| Part # | Description | Color | Wt. |
|----------|--------------------------------|-------|-------|
| PLA300JK | 5/16" x 3" J Bolts w/ Hardware | Zinc | 1 lb. |

Wall-to-Rack Bundle Kit

The all-in-one solution for supporting cable from the wall to a two post equipment rack. This time saving and cost effective solution comes in one single box and is UPS shippable.

Kit includes:

- (1) 60" long 12"W cable runway section
- (1) Wall angle support bracket w/ J-bolts
- (1) Rack-to-runway mounting kit w/ J-bolt
- (1) Pair of runway end caps

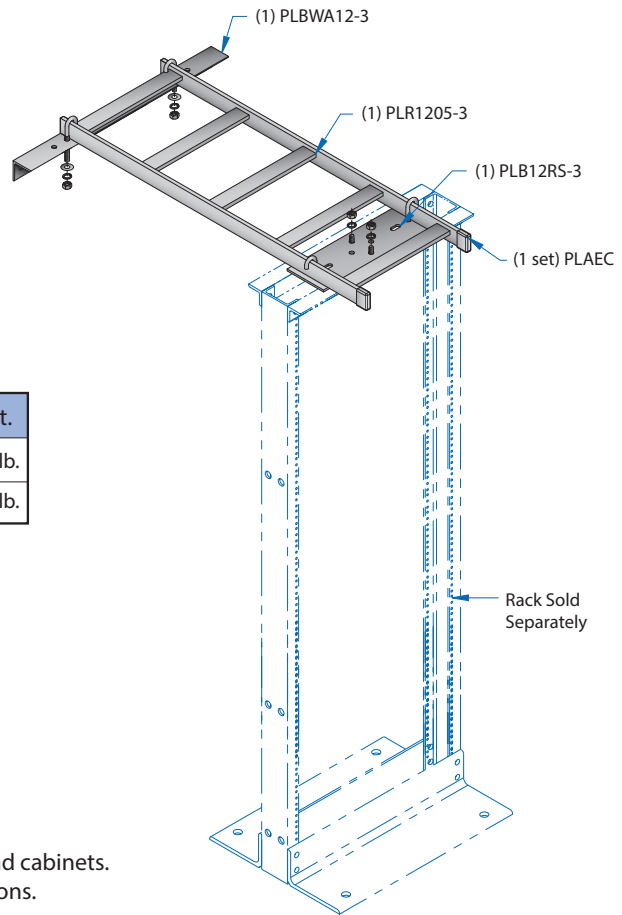

| Part # | Description | Color | Wt. |
|---------------|--|-------|--------|
| PLA12Z21090-3 | (1) 60" Runway, (1) Wall angle, (1) Rack Kit, (2) Caps | Black | 18 lb. |
| RRA19084-3MU | Two Post Rack, 84"H/45U, 19" 12-24 tap rails | Black | 35 lb. |

Patch Panel Bracket

Used to install patch panels or other connection equipment above racks and cabinets. Installs to the side stringer of ladder rack in either above or below orientations. Available in 2U or 4U configurations.

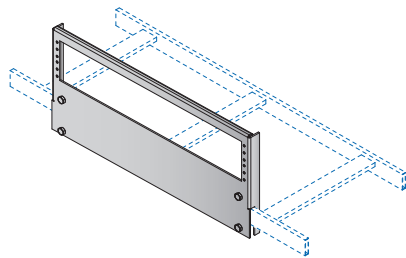

| Part # | Description | Color | Wt. |
|--------------|---|-------|-------|
| PLA1902PV-3 | 2U Patch Panel Bracket w/ Mnt. Brackets | Black | 1 lb. |
| PLA1902PV-4F | 2U Patch Panel Bracket w/ Mnt. Brackets | Gray | 1 lb. |
| PLA1904PV-3 | 4U Patch Panel Bracket w/ Mnt. Brackets | Black | 1 lb. |
| PLA1904PV-4F | 4U Patch Panel Bracket w/ Mnt. Brackets | Gray | 1 lb. |